

CT4447 Series
30 MHz High-Voltage Differential
Probes, cTUVus Listed

User Manual

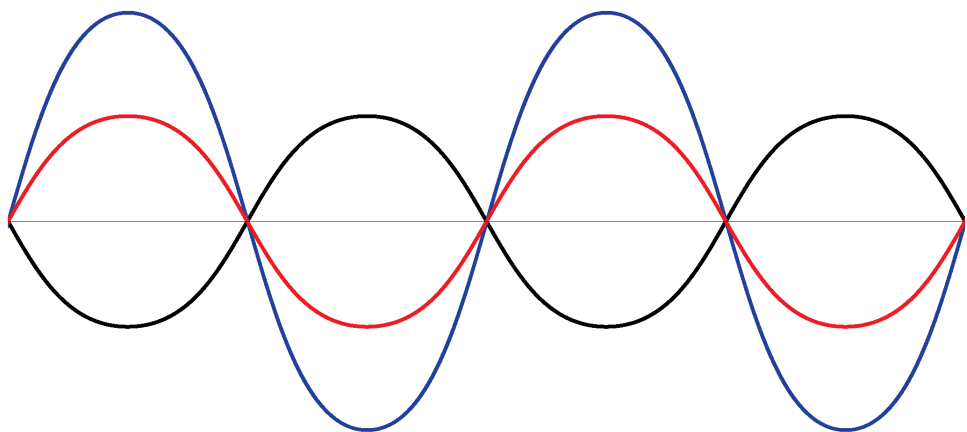

Notices

Copyright Cal Test Electronics, Inc. All rights reserved.

Unauthorized duplication of this documentation material is strictly prohibited. Users are permitted to duplicate and distribute this documentation for internal educational purposes only. Cal Test Electronics is governed by United States and international copyright laws.

Made in Taiwan

User Manual Part Number

451-043-001 Rev. E

Available in electronic format only

Published by:

Cal Test Electronics, Inc.
22820 Savi Ranch Parkway
Yorba Linda, CA 92887 USA

Warranty

LIMITED TWO-YEAR WARRANTY

Cal Test Electronics, Inc warrants these products to be free from defective material or workmanship for a period of 2 years from the date of original purchase. Under this warranty, Cal Test Electronics, Inc is limited to repairing this product when returned to the factory, shipping charges prepaid, within the warranty period.

Units returned to Cal Test Electronics, Inc that have been subject to abuse, misuse, damage, or accident, or have been connected, installed, or adjusted contrary to the instructions furnished by Cal Test Electronics, Inc, or that have been repaired by unauthorized persons, will not be covered by this warranty.

Cal Test Electronics, Inc reserves the right to discontinue models, change specifications, price, or design of this device at any time without notice and without incurring any obligation whatsoever.

The purchaser agrees to assume all liabilities for any damages and/or bodily injury which may result from the use or misuse of this device by the purchaser, his employees, or agents.

THIS WARRANTY IS IN LIEU OF ALL OTHER REPRESENTATIONS OR WARRANTIES EXPRESSED OR IMPLIED AND NO AGENT OR REPRESENTATIVE OF CAL TEST ELECTRONICS, INC IS AUTHORIZED TO ASSUME ANY OTHER OBLIGATION IN CONNECTION WITH THE SALE AND PURCHASE OF THIS DEVICE.

Contents

Notices	2
User Manual Part Number	2
Warranty	2
Contents	3
Compliance Information	5
EMC	5
EC Declaration of Conformity - EMC	5
Safety	5
EC Declaration of Conformity - Low Voltage	5
U.S. and Canadian Recognized Agency Certification	5
Environmental	5
Restriction of Hazardous Substances (RoHS 2)	5
Product End-of-Life Handling	6
Terms & Symbols	7
Terms	7
Symbols	7
Safety Information	8
Safety Notices	8
IEC Measurement Category & Pollution Degree Definitions	11
Introduction	12
Overview	12
Supplied Accessories	14
Setting Up and Using the Probe	15
Setting Up	15
Using	15
Specifications & Characteristics	17
Performance Plots	19
Performance Verification	22
Required Equipment	22
Test Procedures	23
Test Setup	23
Gain Accuracy	24
Rise Time	25

Cleaning26
China RoHS 227
Hazardous Substances Disclosure Table27

Compliance Information

EMC

EC Declaration of Conformity - EMC

Compliance was demonstrated to the following specifications listed in the Official Journal of the European Communities: EMC Directive 2014/30/EU.

EN 61326-1:2013. Electrical equipment for measurement, control and laboratory use- EMC requirements Part 1: General requirements.

Safety

EC Declaration of Conformity - Low Voltage

Compliance was demonstrated to the following specification as listed in the Official Journal of the European Communities: Low Voltage Directive: 2014/35/EU.

EN 61010-1:2010+A1:2019. Safety requirements for electrical equipment for measurement, control and laboratory use - Part 1: General requirements

EN 61010-031:2015 Ed 2.0. Safety requirements for electrical equipment for measurement, control and laboratory use - Part 031: Safety requirements for hand-held probe assemblies for electrical measurement and test.

U.S. and Canadian Recognized Agency Certification

The probe is has been certified by TUV Rheinland Taiwan Ltd. (TUV) to conform to the following safety standard and bears the cTUVus mark.

IEC 61010-031:2015 Ed. 2.0. Safety requirements for electrical equipment for measurement, control and laboratory use - Part 031: Safety requirements for hand-held probe assemblies for electrical measurement and test.

Environmental

Restriction of Hazardous Substances (RoHS 2)

The product and its accessories conform to the Directive 2011/65/EU (RoHS 2) on the restriction of the use of certain hazardous substances in electrical and electronic equipment, inclusive of any modification and addendum to said Directive.

EN ISO 63000:2018 Technical documentation for the assessment of electrical and electronic products with respect to the restriction of hazardous substances.



China RoHS 2 refers to the Ministry of Industry and Information Technology Order No. 32, effective July 1, 2015. See "Hazardous Substances Disclosure Table" on page 27.

Product End-of-Life Handling

The equipment may contain substances that could be harmful to the environment or human health if improperly handled at the product's end of life. To avoid release of such substances into the environment and to reduce the use of natural resources, we encourage you to recycle this product to an appropriate system that will ensure that most of the materials are reused or recycled appropriately.



This product is subject to Directive 2012/19/EU of the European Parliament and the Council of the European Union on waste electrical and electronic equipment (WEEE), and in jurisdictions adopting that Directive, is marked as being put on the market after August 13, 2005, and should not be disposed of as unsorted municipal waste. Please utilize your local WEEE collection facilities in the disposition of this product.

Terms & Symbols

The following terms, symbols, and definitions, individually or combination may appear on the product or in this user manual.

Terms

CAUTION A caution statement calls attention to an operating procedure, practice, or condition, which, if not followed correctly, could result in damage to or destruction of parts or the entire product.

MISE EN GARDE Une mise en garde attire l'attention sur une procédure, une pratique ou une condition d'utilisation qui, si elles ne sont pas suivies correctement, pourraient endommager ou détruire une partie du produit ou le produit entier.

WARNING A warning statement calls attention to an operating procedure, practice, or condition, which, if not followed correctly, could result in injury or death to personnel.

AVERTISSEMENT Un avertissement attire l'attention sur une procédure, pratique ou condition de fonctionnement qui, si elles ne sont pas suivies correctement, pourraient entraîner des blessures, voire la mort de l'utilisateur.

NOTE A note statement calls attention to an operating procedure, practice, or condition, which, should be noted before proceeding.

REMARQUE Un énoncé de note attire l'attention sur une procédure, une pratique ou une condition d'exploitation, qui doit être notée avant de continuer.

Symbols

 CAUTION – Statements or instructions that must be consulted in order to find out the nature of the potential hazard and any actions which must be taken.

 WARNING - HIGH VOLTAGE - possibility of electric shock.

 Earth (ground) TERMINAL - Refer to the instructions accompanying this symbol in this manual.

 The Conformité Européenne (CE) mark is the European Union's (EU) mandatory conformity marking for regulating the goods sold within the European Economic Area (EEA).

 The cTUVus mark certifies that a product complies with North American electrical and safety standards, including those written by Underwriters Laboratories and the CSA Group (CSA).

Safety Information

Safety Notices

These test probes have been designed and tested in accordance with accepted industry and has been supplied in a safe condition. Before applying power, verify that the correct safety precautions are taken (see the following warnings). In addition, note the external markings on the instrument that are described under “Symbols” on page 7.

Throughout this manual and specifically in this section, there are warnings, cautions, and notes that you must follow to ensure safe operation and to maintain the probe in a safe condition.

WARNING To avoid personal injury and to prevent fire or damage to the probe and the products connected to it, review and comply with the following safety Warning and Cautions.

AVERTISSEMENT Pour éviter les blessures corporelles et éviter un incendie ou des dommages à la sonde et aux produits qui y sont connectés, lisez et respectez les avertissements et mises en garde de sécurité suivants.

WARNING Do not use your probe in a manner not specified by the manufacturer. Be aware, that if used in a manner not specified by the manufacturer, the protection provided by the probe assembly may be impaired.

AVERTISSEMENT N'utilisez pas votre sonde d'une manière non spécifiée par le fabricant. Sachez que s'il est utilisé d'une manière non spécifiée par le fabricant, la protection fournie par l'ensemble de sonde peut être altérée.

WARNING The Probe Must be Grounded.



Before making connections to the input leads of the probe, ensure that the output BNC connector is attached to the BNC input channel of the oscilloscope AND the oscilloscope is properly grounded.

AVERTISSEMENT La sonde doit être mise à la terre.

Avant d'effectuer les connexions aux fils d'entrée de la sonde, assurez-vous que le connecteur BNC de sortie est connecté au canal d'entrée BNC de l'oscilloscope ET que l'oscilloscope est correctement mis à la terre.

WARNING Connect and Disconnect the Probe Properly.

Connect the probe to the oscilloscope before connecting the probe inputs to the circuit under test. Disconnect the probe inputs from the circuit under test before disconnecting the probe from the oscilloscope.

AVERTISSEMENT Connectez et déconnectez correctement la sonde.

Connectez la sonde à l'oscilloscope avant de connecter les entrées de la sonde au circuit à tester. Déconnectez les entrées de la sonde du circuit à tester avant de déconnecter la sonde de l'oscilloscope.

WARNING Observe Maximum Working Voltages.



To avoid injury, do not use the probes above 1000 Vrms in a CAT III environment between each input lead and earth or between the two input leads.

Do not operate the CT4447-2 probe above 1000 Vrms mains isolated (200x attenuation)

between the two input leads and above 1000 Vrms mains isolated (both 20x and 200x attenuation) between each input lead and earth.

AVERTISSEMENT Respecter les tensions de fonctionnement maximales. Pour éviter les blessures, n'utilisez pas les sondes au-dessus de 1000 Vrms dans un environnement CAT III entre chaque fil d'entrée et la terre ou entre les deux fils d'entrée. Ne pas faire fonctionner la sonde CT4447-2 au-dessus de 1000 Vrms isolé du secteur (200x atténuation) entre les deux câbles d'entrée et au-dessus de 1000 Vrms isolé du secteur (à la fois 20x et 200x atténuation) entre chaque câble d'entrée et la terre.

WARNING Do not attempt internal service or adjustment. Do not install substitute parts or perform unauthorized modifications to the probe. Service should be carried out by Cal Test authorized service personnel. For any service needs, contact Cal Test Electronics.

AVERTISSEMENT Ne tentez pas d'entretien ou de réglage interne. N'installez pas de pièces de rechange et n'effectuez pas de modifications non autorisées sur la sonde. Le service doit être effectué par le personnel de service autorisé par Cal Test. Pour tout besoin de service, contactez Cal Test Electronics.

WARNING Do Not Operate Without Covers. To avoid electrical shock, or fire hazard, do not operate these probes with cover removed.

AVERTISSEMENT Ne pas utiliser sans couvercles. Pour éviter les chocs électriques ou les risques d'incendie, n'utilisez pas ces sondes avec le couvercle retiré.

WARNING Avoid Exposed Circuit. To avoid injury, remove jewelry such as rings, watches, and other metallic objects. Do not touch exposed connections and components when power is present.

AVERTISSEMENT Évitez les circuits exposés. Pour éviter les blessures, retirez les bijoux tels que bagues, montres et autres objets métalliques. Ne touchez pas les connexions et les composants exposés lorsque l'alimentation est présente.

WARNING Use Proper Power Source. To ensure these probes function well, use either four fresh AA batteries or the supplied USB power cord.

AVERTISSEMENT Utilisez une source d'alimentation appropriée. Pour garantir le bon fonctionnement de ces sondes, utilisez soit quatre piles AA neuves, soit le cordon d'alimentation USB fourni.

WARNING For Indoor Use Only. To avoid electric shock, injury, or fire hazard, do not operate this probe in wet or damp conditions or in an explosive atmosphere.

AVERTISSEMENT Pour une utilisation en intérieur uniquement. Pour éviter les chocs électriques, les blessures ou les risques d'incendie, n'utilisez pas cette sonde dans des conditions humides ou humides ou dans une atmosphère explosive.

WARNING

Periodically inspect your probe and probe wires to check for any damage. Do Not Operate with Visible or Suspected Failures. If you suspect there is damage, have it inspected by Cal Test authorized service personnel.

AVERTISSEMENT

Inspectez périodiquement votre sonde et ses fils pour vérifier qu'ils ne sont pas endommagés. Ne pas utiliser avec des défaillances visibles ou suspectées. Si vous pensez qu'il y a des dommages, faites-le inspecter par le personnel de service autorisé de Cal Test.

WARNING

When it is likely that the ground protection is impaired, you must make the instrument inoperative and secure it against any unintended operation.

AVERTISSEMENT

Lorsqu'il est probable que la protection au sol soit altérée, vous devez rendre l'instrument inopérant et le sécuriser contre tout fonctionnement intempestif.

CAUTION

The probe and its cables are sensitive parts and therefore, you should be careful not to damage them though excessive bending or pulling. Avoid any mechanical shocks to the probe to guarantee accurate performance and protection.

MISE EN GARDE

La sonde et ses câbles sont des pièces sensibles et, par conséquent, vous devez faire attention à ne pas les endommager en les pliant ou en tirant excessivement. Évitez tout choc mécanique sur la sonde pour garantir des performances et une protection précises.

IEC Measurement Category & Pollution Degree Definitions

Measurement Category (CAT) - classification of testing and measuring circuits according to the types of mains circuits to which they are intended to be connected.

Measurement Category *other than* II, III, or IV: circuits that are not directly connected to the mains supply.

Measurement Category II (CAT II): test and measuring circuits connected directly to utilization points (socket outlets and similar prints) of the low-voltage mains installation..

Measurement Category III (CAT III): test and measuring circuits connected to the distribution part of a building's low-voltage mains installation.

Measurement Category IV (CAT IV): test and measuring circuits connected at the source of the building's low-voltage mains installation.

Mains Isolated: is for measurements performed on circuits not directly connected to a mains supply.

Pollution - addition of foreign matter, solid, liquid, or gaseous (ionized gases) that may produce a reduction of dielectric strength or surface resistivity.

Pollution Degree 2 (P2) - only non-conductive pollution occurs except that occasionally a temporary conductivity caused by condensation is expected.

Introduction

Overview

The Cal Test CT4447 Series High-Voltage Differential probes allow conventional earth-grounded oscilloscopes to be used for floating signal measurements - up to 700 V differential or common mode voltage (CT4447-1) and up to 1400 V differential or common mode voltage (CT4447-2).

Each model offers user selectable attenuation setting of 10x & 100x (CT4447-1) and 20x & 200x (CT4447-2), making both probes highly versatile and usable for a broad range of applications including power supply measurements and motor controls.

Both probes are compatible with any oscilloscope with a 1 M Ω BNC female input and feature up to 30 MHz of bandwidth. The probes can be powered by any oscilloscope USB port, internal batteries (4 AA batteries included with the probe), or included mains power adapter.

The figure below show some key features of the CT4447 series probe.

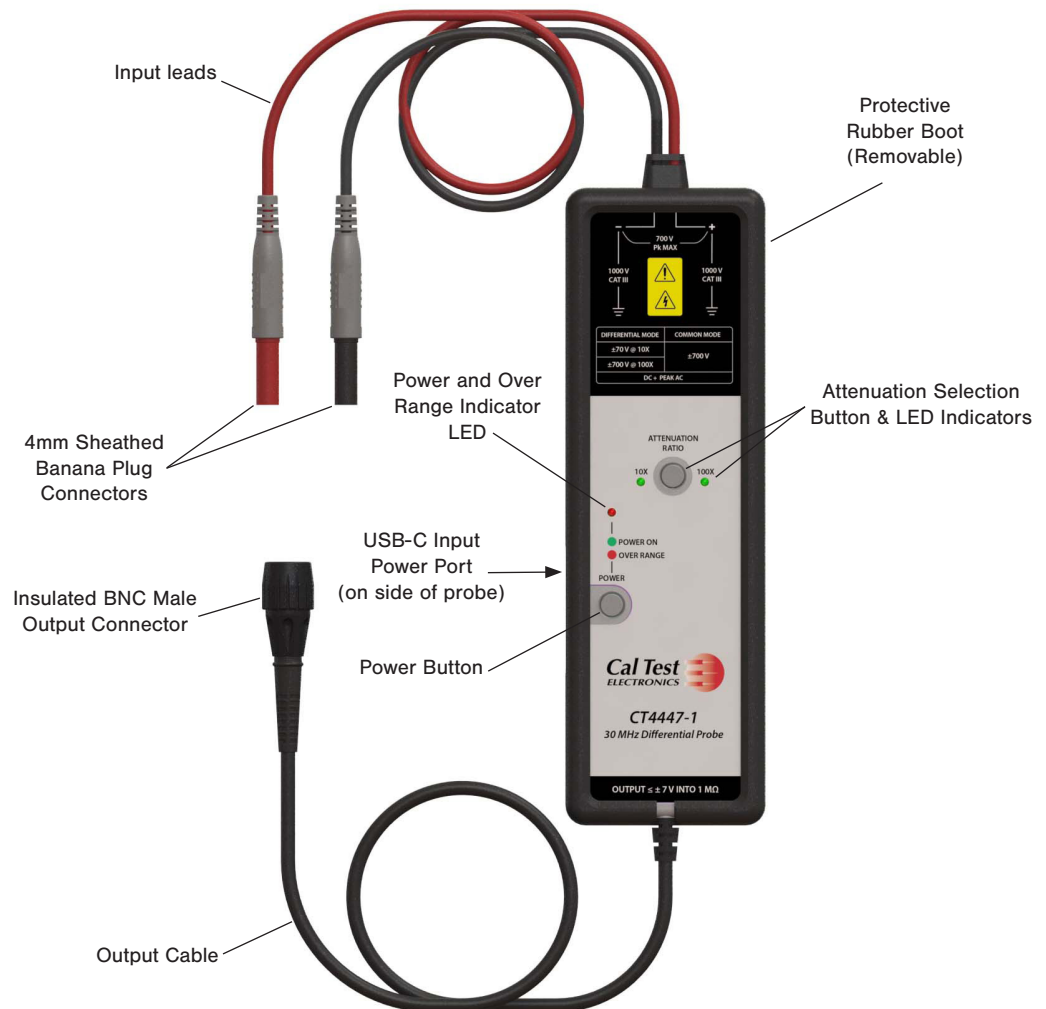







Figure 1 Probe and Supplied Accessories

Table 1 Key Features

Features	Description
Attenuation Selection Button & LED Indicators	Press the Attenuation selection button to switch between the two ranges. LED indicator will light green for attenuation selected.
Power Button	Press to turn unit on. Press and hold for 5 seconds to turn unit off.
Power and Overload indicator LED	LED will turn green when the unit is on. LED will turn red when the unit is in voltage overload condition. (Dimming of LED may indicate low batteries.)
4 mm Sheathed Banana Plug Connectors	Connects the probe to the DUT using probe hook pair provided with the probe.
Insulated BNC Male Output Connector	The probe's output connector is full insulated and connects directly to an oscilloscope's BNC female input channel connector.
USB-C Input Power Port (on side of probe)	Use USB-C Power Port to connect with USB cable when powering from mains adapter or oscilloscope's USB port.

Supplied Accessories

Table 2 CT4447 Accessories

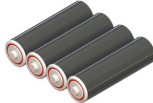
Accessory		Model No.	Quantity
Probe Hook, Pair (black & red)		CT4386	1
Protective Rubber Boot, Black		CT4470-0	1
USB Power Cord (1 m) (USB-A to USB-C)		CT4473-100	1
Power Adapter, N.A. Plugs - USB Jack Input: 100-240 Vac, 50/60 Hz Output: 5 Vdc, 1 A UL Listed		CT4471	1
EU Plug Converter (NA to EU Plugs)		CT4472	1
Batteries, AA		-	4

Setting Up and Using the Probe

WARNING

Before connecting the probe for your measurement, read all the warnings in this section and all of the warnings in the section “Safety Information” on page 8.



AVERTISSEMENT

Avant de connecter la sonde pour votre mesure, lisez tous les avertissements de cette section et tous les avertissements de la section « Informations de sécurité » à la page 8.

Setting Up

1. To use this probe, first insert the four AA batteries into the probe...

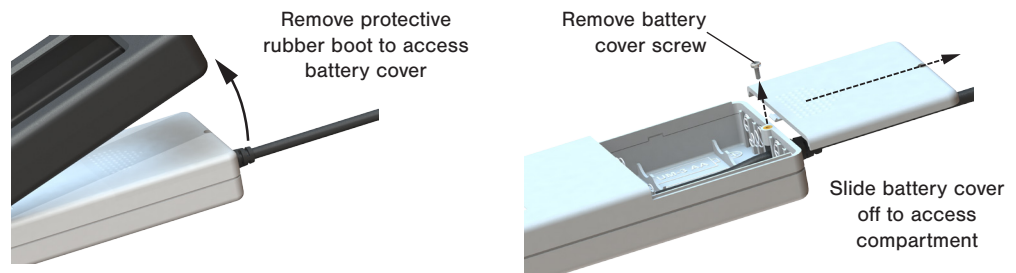

2. OR, connect the USB power cord to the probe (see Figure 1 for the location of the input jack on the probe) and a USB port on the oscilloscope or to the Power Adapter plugged into a mains circuit.

Using

3. Connect the Insulated BNC male output connector to an input channel of the oscilloscope.

WARNING

The Probe Must be Grounded.

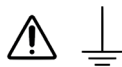

Before making connections to the input leads of the probe, ensure that the output BNC connector is attached to the BNC input channel of the oscilloscope AND the oscilloscope is properly grounded.

AVERTISSEMENT

La sonde doit être mise à la terre.

Avant d'effectuer les connexions aux fils d'entrée de la sonde, assurez-vous que le connecteur BNC de sortie est connecté au canal d'entrée BNC de l'oscilloscope ET que l'oscilloscope est correctement mis à la terre.

4. Select the desired attenuation ratio, 10x or 100x (CT4447-1); 20x or 200x (CT4447-2), via the attenuation selection button.
5. Turn off the high voltage source.
6. Press the probe hooks on its matching color 4 mm sheathed banana plug input lead.
7. Connect the probe hooks to the circuit under test.

WARNING

To protect against electric shock, use only the probe hooks supplied with this probe.

AVERTISSEMENT

Pour vous protéger contre les chocs électriques, utilisez uniquement les crochets de sonde fournis avec cette sonde.

-
8. After confirming that the probe operator is not touching the device under test, turn on the high-voltage source.
 9. Measure the voltage under test and observe the waveform on the oscilloscope.

WARNING

Remember the actual voltage is the attenuation factor greater than the oscilloscope waveform.

AVERTISSEMENT

N'oubliez pas que la tension réelle est le facteur d'atténuation supérieur à la forme d'onde de l'oscilloscope.

10. Turn off high voltage source.
11. Disconnect the probe inputs from the high-voltage source.

Specifications & Characteristics

The probe and oscilloscope should be warmed up for at least 20 minutes before any testing and the environmental conditions should not exceed the probe's specified limits.

NOTE

All entries included in the following tables are characteristics unless otherwise stated.

REMARQUE

Toutes les entrées incluses dans les tableaux suivants sont des caractéristiques, sauf indication contraire.

Table 3 Safety Specifications

Parameter	Condition
IEC/EN 61010-031:2015	Measurement Category III

Table 4 Electrical Specifications (Not Warranted)

Parameter	CT4447-1	CT4447-2
Bandwidth (-3 dB)	30 MHz	30 MHz
Gain Accuracy	±2%	±2%
Attenuation Ratio	10x / 100x	20x / 200x
Rise Time	14 ns	14 ns
Absolute Maximum Rated Input Voltage (each side to ground)	1000 V CAT III	1000 V CAT III
Maximum Differential Input Voltage (DC + AC Peak)	±70 V at 10x ±700 V at 100x	±140 V at 20x ±1400 V at 200x
Maximum Common Mode Input Voltage (DC + AC Peak)	±70 V at 10x ±700 V at 100x	±140 V at 20x ±1400 V at 200x
Input Impedance	5 MΩ, 2 pF (each side to ground)	5 MΩ, 2 pF (each side to ground)
Output Voltage	±7 V (driving 1 MΩ load)	±7 V (driving 1 MΩ load)
Offset (typical)	±20 mV	±20 mV
Noise (typical)	0.7 mVrms	0.7 mVrms
CMRR (typical)	50 Hz: -72 dB 20 kHz: -66 dB 200 kHz: -56 dB	50 Hz: -72 dB 20 kHz: -66 dB 200 kHz: -56 dB
Power Requirements	4 x AA batteries or USB-C cable	4 x AA batteries or USB-C cable
Mains Adapter (N.A. Plugs)	Input: 100-240 V AC, 0.35 A Output: 5 V DC, 1 A	Input: 100-240 V AC, 0.35 A Output: 5 V DC, 1 A

Table 5 Mechanical Specifications (same for both versions)

Parameter	Characteristic
Input Leads Length (each)	45 cm \pm 3 cm
BNC Cable Length	95 cm \pm 3 cm
Dimension (L x W x H)	220 mm, 68 mm, 28 mm (with protective rubber boot)
Weight	488 g (1.08 lb) (with batteries and protective rubber boot)
USB Type C Cable Length	100 cm \pm 3 cm

Table 6 Environmental Specifications (same for both versions)

Parameter	Characteristic
Operating Temperature	-10°C to 40°C (14°F to 104°F)
Storage Temperature	-30°C to 70°C (-22°F to 158°F)
Humidity	\leq 80% RH @ 25°C to 35°C (77°F to 95°F)
Altitude	Operating: 2000 m Non-operating: 15000 m
Pollution Degree	P2

Performance Plots

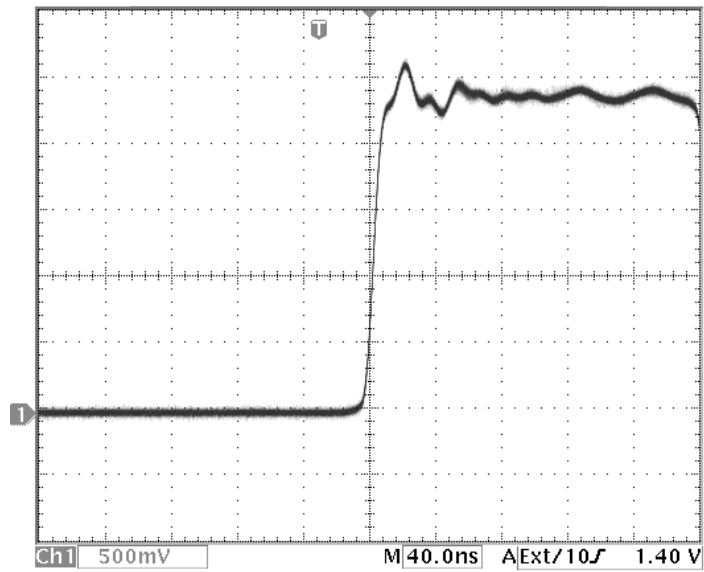

Figure 3 Rise Time

10x attenuation, 10%-90%

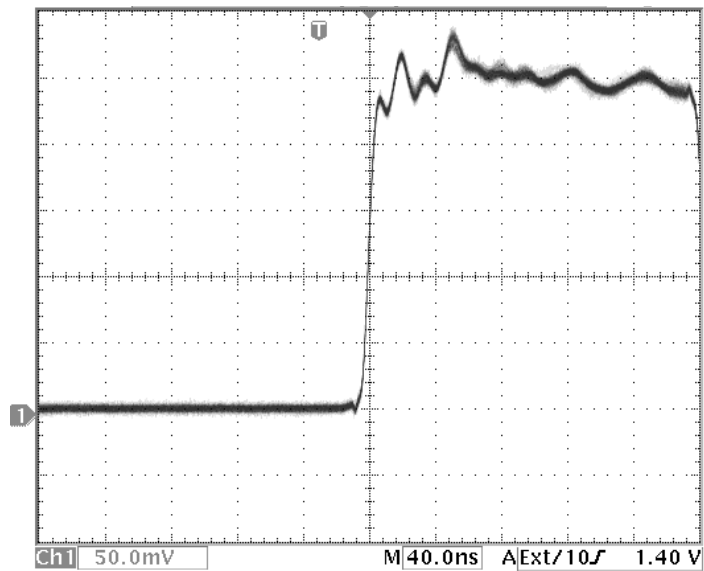

Figure 4 Rise Time

100x attenuation, 10%-90%

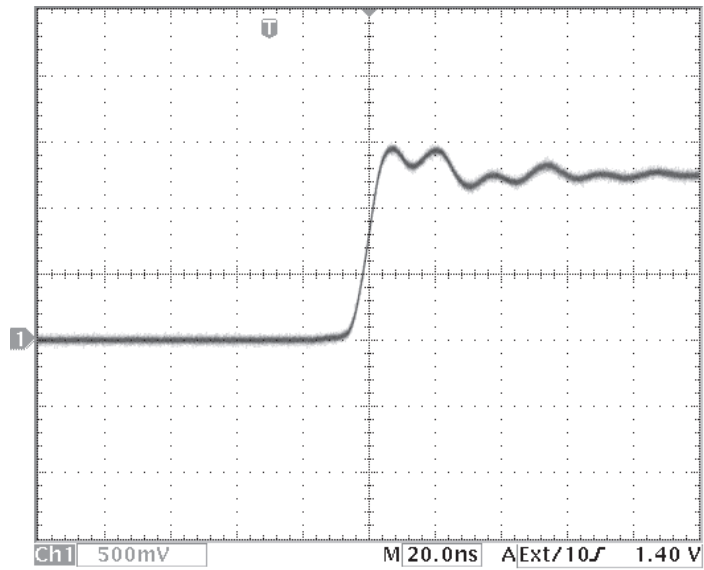

Figure 5 Rise Time

20x attenuation, 10%-90%

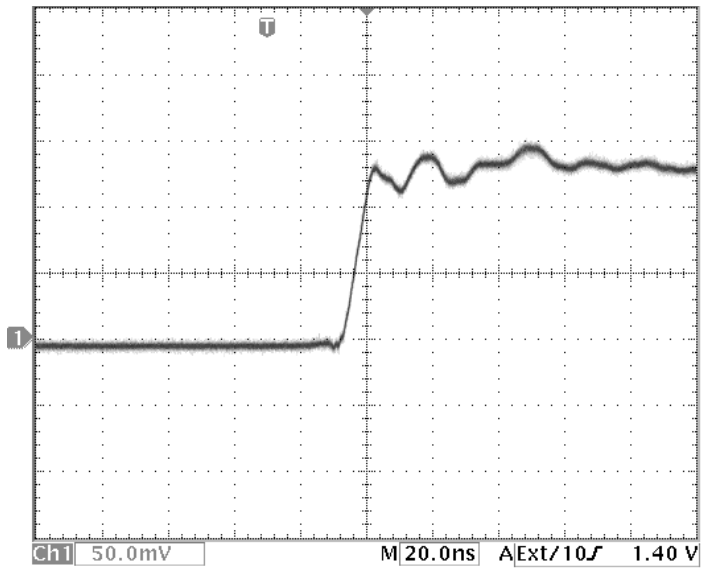

Figure 6 Rise Time

200x attenuation, 10%-90%

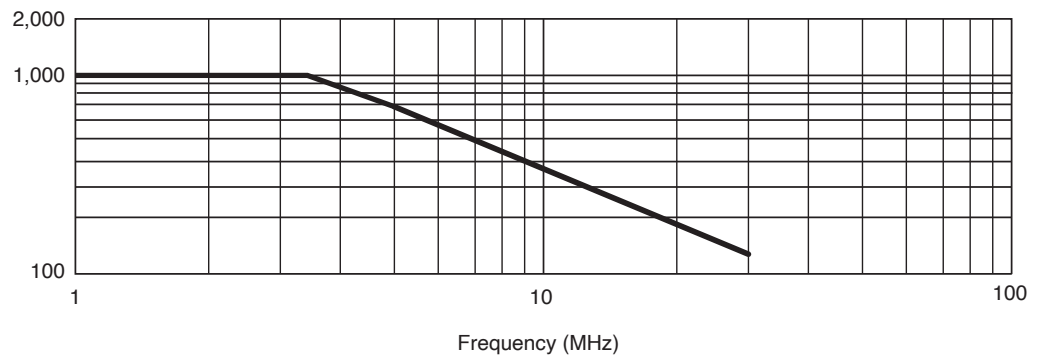

Figure 12 Typical Voltage Derating

Typical derating plot of the absolute maximum input voltage in common mode

Performance Verification

Required Equipment

The follow procedures can be used to test the differential gain accuracy and rise time. Please note that these procedures do not indicate that the characteristics are warranted. They are meant to indicate the probe is functioning properly.

NOTE Allow the probe to warm up at least 20 minutes.

REMARQUE Laisser la sonde se réchauffer au moins 20 minutes.

Table 7 Required Test Equipment

Description	Minimum Requirements	Recommended Product
Oscilloscope	Bandwidth: ≥ 500 MHz, 1 M Ω /50 Ω selectable inputs	Tektronix TDS3052B
Generator/Calibrator	≥ 20 V variable amplitude, 100 Hz square wave, calibrated	Fluke 5522A
Pulse Generator	≥ 50 V, 200 ns, ≤ 500 ps RT	Avtech AVR E2-B
Digital Multimeter (DMM)	100 mV and 1 V True RMS AC ranges, $<\pm 0.3\%$ Accuracy	B&K 5492C
Coax cable	BNC male to BNC male, 50 Ω , 1 m (2)	Cal Test CT4098-100
Adapter	BNC female to 4 mm double banana plugs	Cal Test CT2939
Adapter	BNC female to SMA male	Cal Test CT3316
Adapter	BNC female to female	Cal Test CT2765
Adapter	BNC male to 4 mm double sheathed banana jacks	Cal Test CT2412
Adapter	4 mm banana plug to jack, pair (black & red)	Cal Test CT3089
Terminator	BNC male to female feed-thru, 50 Ω	Cal Test CT2944C-50
Attenuator	BNC male to female, 50 Ω , 6 dB (2x)	Cal Test CT3369A-06

Test Procedures

Test Setup

1. Turn on the oscilloscope.
2. Connect the probe to any channel on the oscilloscope (for warm-up).

NOTE

It is recommended to operate the probe using USB power during verification testing.

REMARQUE

Il est recommandé d'utiliser la sonde en utilisant l'alimentation USB pendant les tests de vérification.

3. Connect the USB cable's to the probe's USB-C power input jack and the AC power adapter to the cable's USB-A connector. Plug the AC adapter into mains line voltage.
4. Turn on the probe and verify the LED lights.
5. Turn on the remaining test equipment and let the probe and equipment warm up for a minimum of 20 minutes.

Gain Accuracy

WARNING

Dangerous voltages will be present on the generator/calibrator output terminals and connection cables. Always verify that the generator/calibrator is in the standby mode before you make any connections to the generator.

AVERTISSEMENT

Des tensions dangereuses seront présentes sur les bornes de sortie du générateur/calibrateur et les câbles de connexion. Vérifiez toujours que le générateur/calibrateur est en mode veille avant d'effectuer des connexions au générateur.

1. Verify that the generator/calibrator output is in standby.
2. Connect the probe output directly to the DMM through the BNC female to 4 mm double banana plugs adapter.

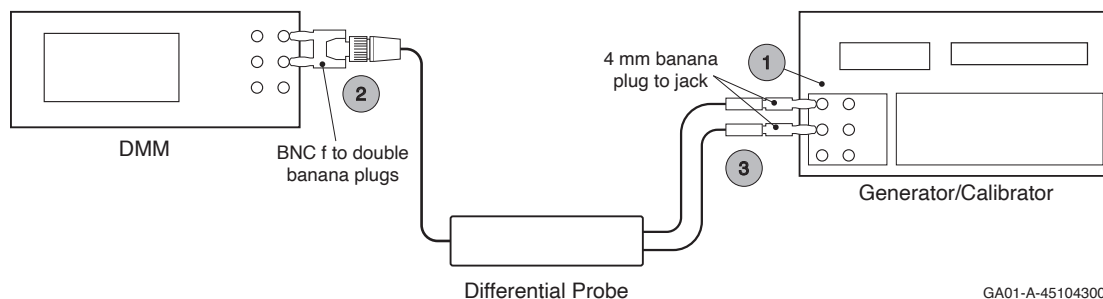

GA01-A-451043001

3. Connect the probe's input leads to the generator/calibrator outputs using banana plug adapters.
4. Set the DMM to AC volts.
5. Set the probe's attenuation range and the generator/calibrator to square wave output, frequency and RMS voltage to the values show in "Table 8 Gain Accuracy Equipment Setting" on page 24, for the probe being tested.
6. Enable the generator/calibrator output and record the probe output (as displayed on the DMM) in the table.
7. Place the generator/calibrator output in standby.
8. Set the probe attenuation to the next range and repeat steps 5 through 8.

Table 8 Gain Accuracy Equipment Setting

Probe		Generator/Calibrator		Probe Output	
Model	Range	Voltage	Frequency	Expected (rms)	Measured (rms)
CT4447-1	10x	10 Vrms	100 Hz	1000 mV ±20 mV	
CT4447-1	100x	30 Vrms	100 Hz	300 mV ±6 mV	
CT4447-2	20x	20 Vrms	100 Hz	1000 mV ±20 mV	
CT4447-2	200x	60 Vrms	100 Hz	300 mV ±6 mV	

Rise Time

1. Verify that the pulse generator output is off and then connect the probe to the oscilloscope input channel.
2. Connect the probe inputs, through the adapters shown below, to the pulse generator output. Set the probe input leads straight and parallel for best signal response.

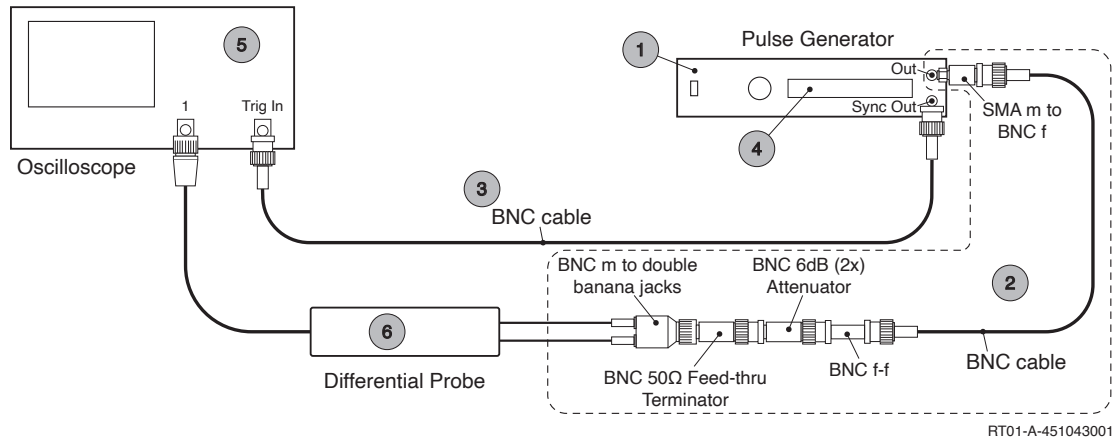

RT01-A-451043001

3. Connect pulse generator output trigger to oscilloscope trigger input.
4. Set the output of the pulse generator to 50 V, 1 kHz, and 200 ns pulse output. Note: the probe input voltage will be 25 V due to the 6 dB (2x) attenuator in the circuit.
5. Set the oscilloscope to 5 V/div, 10 ns/div, BW = full, average = 16.
6. Set the probe attenuation to the first range listed in the table below.
7. Enable the pulse generator output and check that the rise time does not exceed the target rise time value listed in the table. Use the auto-measure feature of the oscilloscope to determine the rise time.
8. Record the rise time in the table.
9. Set the probe attenuation to the next range and adjust the vertical volts/div to display the signal.
10. Record the rise time in the table and disable the pulse generator output.

Table 9 Rise Time Test Equipment Settings

Probe		Pulse Generator Output		Probe Output	
Model	Range	Voltage	Frequency	Expected (ns)	Measured (ns)
CT4447-1	10x	50 V	1 kHz	11.7 ns	
CT4447-1	100x	50 V	1 kHz	11.7 ns	
CT4447-2	20x	50 V	1 kHz	11.7 ns	
CT4447-2	200x	50 V	1 kHz	11.7 ns	

Cleaning

Clean only the exterior probe body and cables. Use a soft cotton cloth light moistened with a mild solution of detergent and water. Do not allow any portion of the probe to be submerged at any time.

WARNING Dry the probe thoroughly before attempting to make voltage measurements.

AVERTISSEMENT Séchez soigneusement la sonde avant d'essayer d'effectuer des mesures de tension.

CAUTION Do not subject the probe to solvents or solvent fumes as these can cause deterioration of the probe body and cables.

MISE EN GARDE Ne soumettez pas la sonde à des solvants ou à des vapeurs de solvants car ceux-ci peuvent détériorer le corps de la sonde et les câbles.

China RoHS 2

Hazardous Substances Disclosure Table



China RoHS 2 refers to the Ministry of Industry and Information Technology Order No. 32, effective July 1, 2015, titled Management Methods for the Restriction of the Use of Hazardous Substances in Electrical and Electronic Products. To comply with China RoHS 2, we determined this product's Environmental Protection Use Period (EPUP) to be 25 years in accordance with the Marking for the Restricted Use of Hazardous Substances in Electronic and Electrical Products, SJT 11364.

中國 RoHS 2 指工業和信息化部令第 32 號，自 2015 年 7 月 1 日起生效，題為《電氣電子產品有害物質限制使用管理辦法》。為符合中國 RoHS 2，我們根據電子電氣產品有害物質限制使用標誌 SJT 11364 將本產品的環保使用期限 (EPUP) 確定為 25 年。

Part Name 零件名稱	Hazardous Substance 有害物質					
	Lead (Pb) 鉛	Mercury (Hg) 汞	Cadmium (Cd) 鎘	Hexavalent Chromium (Cr (VI)) 六價鉻	Polybrominated biphenyls (PBB) 多溴聯苯	Polybrominated diphenyl ethers (PBDE) 多溴二苯醚
Printed Circuit Board Assemblies 印刷電路板組件	X	O	O	O	O	O
Electrical Components 電氣元件	X	O	O	O	O	O
Metal Components 金屬部件	X	O	O	O	O	O
Plastic Components 塑料部件	O	O	O	O	O	O

This table is made per guidance of SJ/T 11364.
該表是根據 SJ/T 11364 的指南製作的。

O: Indicates that this hazardous substance contained in all of the homogeneous materials for the part is below the limit requirement in GB/T 26572.
O: 表示該有害物質在該部件的所有均質材料中的含量低於 GB/T 26572 中的限量要求。

X: Indicates that this hazardous substance contained in at least one of the homogeneous materials used for this part is above the limit requirement in GB/T 26572.
X: 表示該有害物質在用於該部件的至少一種均質材料中的含量高於 GB/T 26572 中的限量要求。



© Cal Test Electronics, Inc.
Electronic Format Only
Manual Part Number: 451-043-001
Revision: E

